

HDC-1000 Dual Digital Music Controller



Now that you Own it...

Read it!



Important Notice

Before operating this unit, please verify that you have the latest firmware version available from our website - <http://www.cortex-pro.com>. New versions of the HDC-1000 firmware will include additional features, bug fixes, and enhanced compatibility to guarantee optimum performance of your unit. There are even Spanish and French language versions, to make operating the HDC-1000 easier than ever!

Additionally, please also download our **FREE** Cortex Database Creation Software, which allows you to create searchable databases of your entire music collection within minutes! This indispensable utility is designed to save you time when preparing large storage devices to use with the HDC-1000.

To find out what version of HDC-1000 firmware you are running:

1. Power on the HDC-1000 with **NO DEVICES CONNECTED**.
2. At the prompt that says 'Insert Devices,' press the INFO button.
3. The screen will display the version number of the currently installed HDC-1000 firmware.

To upgrade your firmware to the newest version:

1. Using your PC, download the firmware update to the root directory of your USB storage device (X:\ where X is the letter of the drive). We recommend Internet Explorer.
2. Connect the USB storage device to the HDC-1000.
3. Power on the HDC-1000, and select the aforementioned device.
4. The unit will display the date/version of the new update, and will ask if you want to update. Select 'YES,' and press enter.
5. The unit will go through a 6-step update procedure, after which the power will automatically shut down. When the unit is powered on again, you will be running the latest firmware.

Warning: If the power is interrupted or the USB device is removed during this process, it can damage the operating system of the unit.

For more detailed information about Firmware Updates, including screen shots, please see the Firmware Updates section of the manual (page 24).

Table of Contents

Warnings and WEEE.....	2
Introduction.....	3
Features.....	4
Compatibility and Recommended Peripherals.....	5
Device Requirements.....	5
Care and Maintenance.....	6
Operating Conditions.....	6
Legal Info.....	6
Setup Guide & Parts Diagram.....	7
Rear Panel & Connections.....	7
Front Panel & Functions.....	8-9
Using the HDC-1000.....	10
Preparing for Use.....	10
Selecting Devices & Database Creation.....	11
Database Creation (continued).....	12
File Browser & Search Options.....	13
Search Options (continued).....	14-15
Info Button & Track Attributes.....	16
Play Mode & Single Auto Cue.....	17
Time Display.....	18
Pitch Control.....	18
Jog Mode.....	19
Playback Navigation Controls.....	19
Cue Points and Cue Memorization.....	20
Device Menu.....	21
Shuffle Mode.....	22
Soft Power.....	22
Setup Preferences.....	23
Firmware Updates.....	24
Error Messages.....	25
Technical Specifications.....	26
Warranty Information.....	27

IMPORTANT WARNING & SAFETY INSTRUCTIONS

PLEASE READ PRIOR TO OPERATING THIS DEVICE!

CAUTION: This product satisfies FCC regulations when shielded cables and connectors are used to connect the unit to other equipment. To prevent electromagnetic interference with electric appliances such as radios and televisions, use shielded cables and connectors for connections.

The exclamation point within an equilateral triangle is intended to alert the user to the presence of important operating and maintenance (servicing) instructions in the literature accompanying the appliance.

The lightning flash with arrowhead symbol, within an equilateral triangle, is intended to alert the user to the presence of uninsulated "dangerous voltage" within the product's enclosure that may be of sufficient magnitude to constitute a risk of electric shock to persons.

READ INSTRUCTIONS: All the safety and operating instructions should be read before the product is operated.

RETAIN INSTRUCTIONS: The safety and operating instructions should be retained for future reference.

HEED WARNINGS: All warnings on the product and in the operating instructions should be adhered to.

FOLLOW INSTRUCTIONS: All operating and use instructions should be followed.

CLEANING: The product should be cleaned only with a polishing cloth or a soft dry cloth. Never clean with furniture wax, benzene, insecticides or other volatile liquids since they may corrode the cabinet.

ATTACHMENTS: Do not use attachments not recommended by the product manufacturer as they may cause hazards.

WATER & MOISTURE: Do not use this product near water, for example, near a bathtub, wash bowl, kitchen sink, or laundry tub; in a wet basement; or near a swimming pool; and the like.

ACCESSORIES: Do not place this product on an unstable cart, stand, tripod, bracket, or table. The product may fall, causing serious injury to a child or adult, and serious damage to the product. Use only with a cart, stand, tripod, bracket, or table recommended by the manufacturer, or sold with the product. Any mounting of the product should follow the manufacturer's instructions, and should use a mounting accessory recommended by the manufacturer.

CART: A product and cart combination should be moved with care. Quick stops, excessive force, and uneven surfaces may cause the product and cart combination to overturn. **SEE FIGURE A.**



VENTILATION: Slots and openings in the cabinet are provided for ventilation and to ensure reliable operation of the product and to protect it from overheating, and these openings must not be blocked or covered. The openings should never be blocked by placing the product on a bed, sofa, rug, or other similar surface. This product should not be placed in a built-in installation such as a bookcase or rack unless proper ventilation is provided or the manufacturer's instructions have been adhered to.

POWER SOURCES: This product should be operated only from the type of power source indicated on the marking label. If you are not sure of the type of power supply to your home, consult your product dealer or local power company.

LOCATION: The appliance should be installed in a stable location.

NON-USE PERIODS: The power cord of the appliance should be unplugged from the outlet when left unused for a long period of time.

GROUNDING OR POLARIZATION:

- If this product is equipped with a polarized alternating current line plug (a plug having one blade wider than the other), it will fit into the outlet only one way. This is a safety feature. If you are unable to insert the plug fully into the outlet, try reversing the plug. If the plug should still fail to fit, contact your electrician to replace your obsolete outlet. Do not defeat the safety purpose of the polarized plug.

- If this product is equipped with a three-wire grounding type plug, a plug having a third (grounding) pin, it will only fit into a grounding type power outlet. This is a safety feature. If you are unable to insert the plug into the outlet, contact your electrician to replace your obsolete outlet. Do not defeat the safety purpose of the grounding type plug.

POWER-CORD PROTECTION: Power-supply cords should be routed so that they are not likely to be walked on or pinched by items placed upon or against them, paying particular attention to cords at plugs, convenience receptacles, and the point where they exit from the product.

OUTDOOR ANTENNA GROUNDING: If an outside antenna or cable system is connected to the product, be sure the antenna or cable system is grounded so as to provide some protection against voltage surges and built-up static charges. Article 810 of the National Electrical Code, ANSI/NFPA 70, provides information with regard to proper grounding of the mast and supporting structure, grounding of the lead-in wire to an antenna discharge unit, size of grounding conductors, location of antenna-discharge unit, connection to grounding electrodes, and requirements for the grounding electrode. **SEE FIGURE B.**

LIGHTNING: For added protection for this product during a lightning storm, or when it is left unattended and unused for long periods of time, unplug it from the wall outlet and disconnect the antenna or cable system. This will prevent damage to the product due to lightning and power-line surges.

POWER LINES: An outside antenna system should not be located in the vicinity of overhead power lines or other electric light or power circuits, or where it can fall into such power lines or circuits. When installing an outside antenna system, extreme care should be taken to keep from touching such power lines or circuits as contact with them might be fatal.

OVERLOADING: Do not overload wall outlets, extension cords, or integral convenience receptacles as this can result in a risk of fire or electric shock.

OBJECT & LIQUID ENTRY: Never push objects of any kind into this product through openings as they may touch dangerous voltage points or short-out parts that could result in a fire or electric shock. Never spill liquid of any kind on the product.

SERVICING: Do not attempt to service this product yourself as opening or removing covers may expose you to dangerous voltage or other hazards. Refer all servicing to qualified service personnel.

DAMAGE REQUIRING SERVICE: Unplug this product from the wall outlet and refer servicing to qualified service personnel under the following conditions:

- When the power-supply cord or plug is damaged.
- If liquid has been spilled, or objects have fallen into the product.
- If the product has been exposed to rain or water.
- If the product does not operate normally by following the operating instructions. Adjust only those controls that are covered by the operating instructions as an improper adjustment of other controls may result in damage and will often require extensive work by a qualified technician to restore the product to its normal operation.
- If the product has been dropped or damaged in any way.
- When the product exhibits a distinct change in performance, this indicates a need for service.

REPLACEMENT PARTS: When replacement parts are required, be sure the service technician has used replacement parts specified by the manufacturer or have the same characteristics as the original part. Unauthorized substitutions may result in fire, electric shock, or other hazards.

SAFETY CHECK: Upon completion of any service or repairs to this product, ask the service technician to perform safety checks to determine that the product is in proper operating condition.

WALL OR CEILING MOUNTING: The product should not be mounted to a wall or ceiling.

HEAT: The product should be situated away from heat sources such as radiators, heat registers, stoves, or other products (including amplifiers) that produce heat.

DISPOSAL: This product shall not be treated as household waste. Instead it shall be handed over to the applicable collection point for the recycling of electrical and electronic equipment. By ensuring this product is disposed of correctly, you will help prevent potential negative consequences for the environment and human health, which could otherwise be caused by inappropriate waste handling of this product. The recycling of materials will help to conserve natural resources. For more detailed information about recycling of this product, please contact your local city office, your household waste disposal service or the shop where you purchased the product.

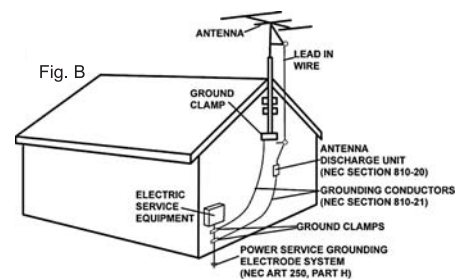

Fig. B
NEC — NATIONAL ELECTRICAL CODE



Foreward

Thank you for purchasing our Cortex HDC-1000.. We are confident that the Cortex platform of products will not only make your life easier through the use of the latest technological advancements in cross-platform connectivity and sound reproduction but will raise the bar for DJ and pro audio products. With the proper care & maintenance, your unit will likely provide years of reliable, uninterrupted service. All Cortex products are backed by a 1-year limited warranty*.

Preparing for First Use

Please insure that you find these accessories included with the HDC-1000:

RCA audio cables.....	2
Power supply.....	1
Tabletop mounting stands.....	2
Mounting hardware for tabletop stands.....	1
Operating instructions.....	1
Warranty Card.....	1
USB port protector cap.....	1



Dear Customer:

Selecting fine audio equipment such as the unit you've just purchased is only the start of your musical enjoyment. Now it's time to consider how you can maximize the fun and excitement your equipment offers. This manufacturer and the Electronic Industries Association's Consumer Electronics Group want you to get the most out of your equipment by playing it at a safe level. One that lets the sound come through loud and clear without annoying blaring or distortion-and, most importantly, without affecting your sensitive hearing.

Sound can be deceiving. Over time your hearing "comfort level" adapts to higher volumes of sound. So what sounds "normal" can actually be loud and harmful to your hearing. Guard against this by setting your equipment at a safe level BEFORE your hearing adapts.

To establish a safe level:

- Start your volume control at a low setting.
- Slowly increase the sound until you can hear it comfortably and clearly, and without distortion.

Once you have established a comfortable sound level:

- Set the dial and leave it there.

Taking a minute to do this now will help to prevent hearing damage or loss in the future. After all, we want you listening for a lifetime.



We Want You Listening For A Lifetime

Used wisely, your new sound equipment will provide a lifetime of fun and enjoyment. Since hearing damage from loud noise is often undetectable until it is too late, this manufacturer and the Electronic Industries Association's Consumer Electronics Group recommend you avoid prolonged exposure to excessive noise. This list of sound levels is included for your protection.

Decibel Level Example

30	Quiet library, soft whispers
40	Living room, refrigerator, bedroom away from traffic
50	Light traffic, normal conversation, quiet office
60	Air conditioner at 20 feet, sewing machine
70	Vacuum cleaner, hair dryer, noisy restaurant
80	Average city traffic, garbage disposals, alarm clock at two feet.

THE FOLLOWING NOISES CAN BE DANGEROUS UNDER CONSTANT EXPOSURE

90	Subway, motorcycle, truck traffic, lawn mower
100	Garbage truck, chain saw, pneumatic drill
120	Rock band concert in front of speakers, thunderclap
140	Gunshot blast, jet plane
180	Rocket launching pad

Information courtesy of the Deafness Research Foundation.



Features

The Cortex HDC-1000 has been designed & engineered to provide digital music playback and manipulation features demanded by professional users. The HDC-1000 is designed to liberate DJs from the issues associated with PC-based solutions, by eliminating the need for a computer during performance. The HDC-1000 also offers superior sound quality and flexibility than that of a typical PC.

Jog Wheels

The Jog Wheels on the HDC-1000 provide highly precise control for a variety of functions.

- **Pitch Bend**

Changes the pitch of the music being played back with the intensity relative to the direction and speed of rotation.

- **FF/REW Search**

When the JOG MODE indicator is lit, rotating the JOG WHEEL will advance quickly through the currently playing track, relative to the direction and speed of rotation.

- **Frame Search**

When the unit is in PAUSE mode, rotating the JOG WHEEL will advance by frame, for the purpose of finding specific time locations or setting a cue point.

- **Selection**

In any context which requires a selection from the user, the JOG WHEEL may be used as a substitute for the NAVIGATOR keypad. It will still be necessary to use the ENTER key in the center of the NAVIGATOR keypad to confirm your selection.

Pitch Control

- **0.05% pitch precision**

In order to provide more precise pitch adjustment, the unit is able to advance in increments of 0.05%. This aids in beatmatching between two musical programs. 0.05% precision is only available at 4 and 8% pitch ranges.

- **Multiple pitch ranges**

With pitch ranges of 4, 8, 12, and 24%, the pitch control's minimum and maximum values can be altered to augment or reduce the amount of pitch adjustment to a musical program.

- **Pitch ON/OFF**

By pressing the PITCH + and PITCH - buttons simultaneously, this toggles whether or not the unit will respond to changes via the PITCH CONTROL slide. The Pitch ON/OFF feature also functions as a pitch reset, when it is used to turn the pitch OFF.

LCD Text Display

The backlit 80 character text display shows a variety of information, including track titles, times, pitch, setup options, and search parameters. Unlike a conventional player, the full text display allows more extensive visualization of parameters.

Cross-Platform USB Connectivity

The HDC-1000 offers an unparalleled level of connectivity with all driver-less USB devices. The Cortex line of products are the first to offer the ability to manipulate music stored on USB devices such as hard drives, flash memory, optical drives, and personal music players, regardless of platform. Through this innovation, DJs are able to consolidate the amount of equipment and music needed during a performance. Even more USB devices can be connected with the use of a compatible USB hub.

User-Upgradeable Firmware

Part of a good product is the manufacturer's commitment to service after the sale. With all Cortex products, upgradeable firmware ensures the ability to improve the functionality and support for 3rd party storage devices, even for units that are already in the field. Please consult the Cortex website (<http://www.cortex-pro.com>) for software updates.

CD Audio Support

Despite the fact that a vast majority of people have access to USB storage devices or portable music players, the Cortex HDC-1000 supports the playback of CD Audio discs through a compatible USB external CD-ROM, CD-RW, DVD-ROM, or DVD-RW drive. This is particularly useful for DJs making a gradual migration, or for playing CDs provided by clients. Note that both sides can share one optical drive, but only one track can be played at a time. For dual-deck CD functionality, simply connect two USB optical drives.

Database-Driven Music Management

The entire line of Cortex Digital Music Players allows for the management of music collections via a database-driven system. Using this method, the database can be queried based on a number of different criteria. This allows DJs to search by artist, title, genre, album, or search string. Using this method allows the DJ to find a specific music selection within seconds. The database is saved to the storage device the music is being drawn from, so that it can be used with any Cortex unit, whether it's in your personal rig or at a club!

Cue Point Storage

Cue Points that have been memorized using the HDC-1000 are also stored along with the database information on the active storage device. Once a Cue Point has been stored, DJs have the ability to recall it each time that track is loaded.

iPod Playlist Support

The HDC-1000 supports iPod Playlists, which can be created using Apple iTunes®. When there are iPod Playlists available to be loaded, a menu option will appear in the main Search Options menu

Compatibility & Recommended Peripherals

A Word About Compatibility

The HDC-1000 (and all Cortex products) are designed to interface with all driverless USB devices. This means that if the product does not require proprietary driver software and can be accessed natively by a PC or Macintosh computer, it should be compatible with the Cortex. Note that just because the product works on a computer without using an included driver disk, that does not mean that it is truly driverless.

In theory (but sometimes not in practice), any device that doesn't require a driver should work just fine with the Cortex. However, varying specifications of certain products (primarily USB flash memory) sometimes might present an incompatibility issue. As one might imagine, testing every USB peripheral on the market would be a lifelong quest, and the introduction of new peripherals on the daily basis would make it even more difficult.

If you are having trouble with a specific peripheral, please find the compatibility advisory section of our website, and let us know! In the vast majority of cases, support can be added for sub-standard units that deviate from typical specifications.

- **DAE capability for Audio CD playback via CD-ROM/DVD-ROM drive**
In order to play back audio CDs on a CD-ROM/DVD-ROM drive, the drive itself must support bit-accurate Digital Audio Extraction (DAE for short). If the drive does not support bit-accurate DAE, it is possible that you may notice anomalies such as pops & clicks during playback.

- **USB Hubs must be Powered, not Passive (non-powered)**

Although the Cortex is able to provide power to the vast majority of USB-powered devices, USB Hubs should be powered. Although a passive hub itself will function, the extraneous current draw of the devices connected to it may cause instability when operating the Cortex.

- **Write-protection must be Disabled (where applicable)**

When using a writeable device (hard drive, music player, flash memory), any write-protection must be disabled. Otherwise the Cortex will not be able to store the database it has created.

Certified-Compatible Devices

For a list of devices that have been tested and are certified to be compatible with the HDC-1000, please visit the support section of our website at <http://www.cortex-pro.com>

Device Requirements

- **USB Compliance**

The storage device must comply to USB 1.0, 1.1, or 2.0 specifications. Wireless USB devices are not supported.

- **Devices should be dedicated for use with the Cortex, if possible**

For optimal performance, the storage devices you use should be dedicated for audio-only use. No other files should be stored on the device, other than the audio and database files used by the Cortex.

- **Drives must have only one partition**

The HDC-1000 cannot switch between multiple partitions - it recognizes the first partition on the active device. This is crucial for the efficiency of the database driven search.

- **FAT32, NTFS, or HFS+ File System for Flash Memory and Hard Drives**

All storage devices must be formatted using FAT32, NTFS, or HFS+ file systems. On Windows PCs, all hard drives will use FAT32 or NTFS file systems, with NTFS common for Windows XP and later. HFS+ is the file system that is used by Macintosh and Linux-based machines.

- **NTFS is read-only!**

If you are using an external hard drive that is formatted using the NTFS file system, you will not be able to create a database using the HDC-1000 unit. Instead, you should use the Cortex Database Creation (DBC) software for PC or Mac. This should not impact the majority of users, as the only devices that will be typically formatted using NTFS are extremely large hard drives over 32 gigs. When there is a large music collection, using the DBC software will be dramatically faster at creating a database.

Additional Information

Maintaining Storage Devices

When using writeable storage devices, such as hard drives, and hard-drive-based music players (iPod, Zen), certain maintenance might be required. Because the Cortex units use streaming technology to manipulate more than one music file from one device simultaneously, hard drives and hard-drive based units need to be defragmented regularly to ensure the integrity of the streamed files.

Fragmentation refers to “the condition of a disk in which files are divided into pieces scattered around the disk. Fragmentation occurs naturally when you use a disk frequently, creating, deleting, and modifying files. At some point, the operating system needs to store parts of a file in non-contiguous clusters. This is entirely invisible to users, but it can slow down the speed at which data is accessed because the disk drive must search through different parts of the disk to put together a single file.”

Maintaining these storage devices must be done via your computer, and should be performed whenever there has been a substantial change to your music library (adding/deleting music). Note that failure to maintain your storage devices might result in delayed access times and glitchy audio playback.

- **With Windows XP based machines**

First, connect the storage device that you wish to defragment. If you are connecting a hard-drive based music player, such as an Apple iPod or Creative Zen, make sure to exit any applications that may be launched on connection.

To load **Disk Defragmenter**, go to the Start menu, and find **Disk Defragmenter** under Accessories/System Tools.

When **Disk Defragmenter** has been loaded, select the device to be defragmented, and click the ‘Defragment’ button at the bottom of the window.

For more information on defragmenting, consult the Windows Help guide.

- **With Apple Macintosh Machines**

According to Apple, provisions within the HFS file allocation system diminish the need for any type of defragmentation. Because of this, there is no software included in OSX to accomplish this. However, this does not guarantee that defragmentation will not be necessary for external storage devices and portable music players.

For more information on Apple’s claims, see this article:
<http://docs.info.apple.com/article.html?artnum=25668>

Always Make Backups!

Due to the sometimes fragile state of PC components, we insist that you make backups of the storage devices that you plan on using with the Cortex. **All** hard drives (and hard-drive-based portable music players), are prone to failure - they have moving parts inside. Instead of taking a chance that your hard drive will last one more performance, one more month, or one more year, it is a far more intelligent choice to back up your data for the worst case scenario.

Neither Cortex nor your retailer will be held responsible for data loss because of the lack of backups.

Cleaning the Unit

To clean the HDC-1000, use only a dry soft cloth and/or compressed air. If the unit is soiled with stubborn dirt, we suggest using a 2:1 solution of distilled water and 30% isopropyl alcohol. Avoid using harsh cleaning chemicals such as benzene, paint thinner, bleach, or hydrochloric acid, which will damage the unit.

Operating Conditions

For optimum performance, the temperature of the operating environment should be between +5° C to +35° C (+41° F - +95° F). Failure to maintain proper operating temperature may result in difficulty reading the LCD display, thermal overload, or system-wide instability. Avoid exposing the unit to direct sunlight.

When placing the unit in an installation, make sure that it is placed on a stable surface, as far away from vibrations as possible. Even though the Cortex is impervious to vibration, the storage devices (specifically hard drive based ones) that are designed to be used in conjunction with it are typically not. Also be sure *not* to place or use the player on heat generating sources, such as amplifiers or near spotlights.

Never use any other power supply other than the one provided with the unit, as doing so may damage the unit and void the warranty. The power supply included with the HDC-1000 is a custom made supply and is not commercially available.

Lawful Use of HDC-1000

Neither Cortex nor its dealers assume responsibility for the use made of the HDC-1000. The user must ensure he/she has all relevant licences and consents in place (whether for copyright/public performance, performers rights, moral rights or otherwise) to allow the lawful use of the HDC-1000. This is likely to include licences from organizations administering performance rights in audio recordings or consents from any other relevant rights holders.

The Cortex line of units, although designed to streamline the process by which DJs perform, is not designed as a tool to facilitate media piracy. We urge that our users legitimately purchase the music they plan to use, and support the artists who make it possible for them to sustain a career as a professional entertainer.

Parts Diagram and Functions

Rear Panel

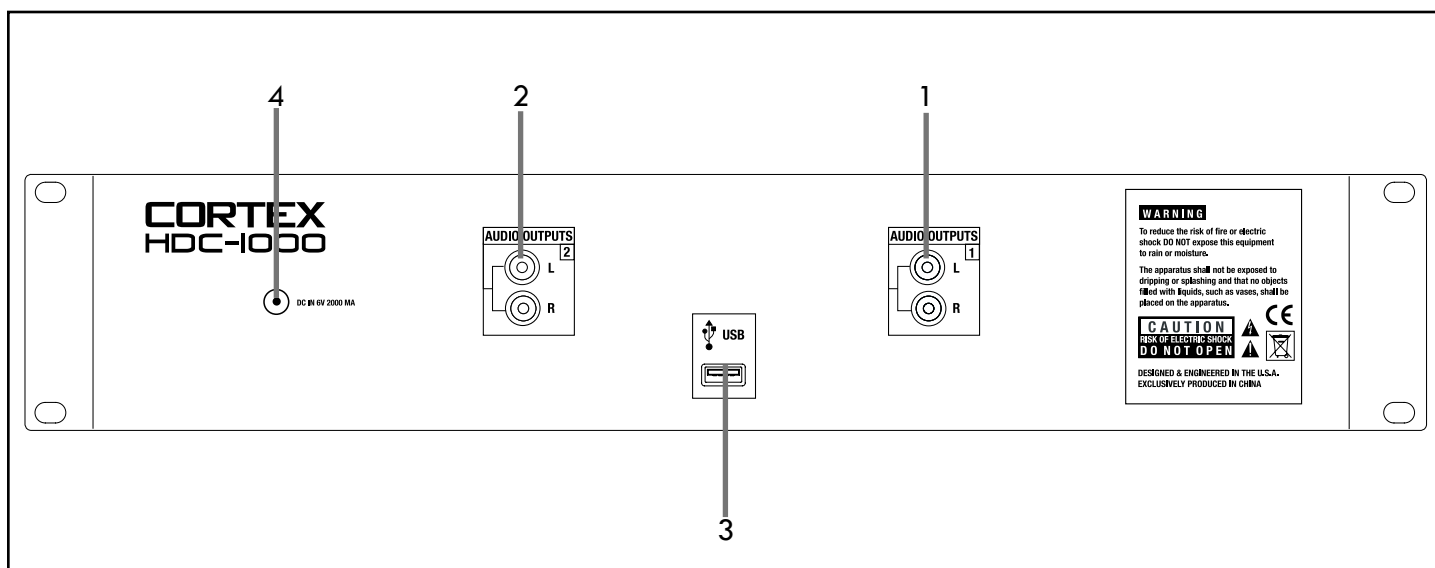
**1. AUDIO OUT L/R RCA connectors, side 1**

RCA type unbalanced stereo audio output. These connectors output audio signal generated from Side 1 of the HDC-1000 unit.

2. AUDIO OUT L/R RCA connectors, side 2

RCA type unbalanced stereo audio output. These connectors output audio signal generated from Side 2 of the HDC-1000 unit.

3. USB connector (type A)

This connector is used to attach the USB mass storage device that contains your music library. Suitable mass storage devices include, but are not limited to: external hard drives, flash memory, portable digital music players, CD/DVD-ROM drives, memory card readers, and active USB hubs.

4. DC inlet w/security clamp

This connector is used in conjunction with the AC/DC adaptor to power the unit. Next to the DC inlet connector is a security clamp, which can be fastened over top of the cable to prevent it from being dislodged.

Parts Diagram and Functions

Front Panel

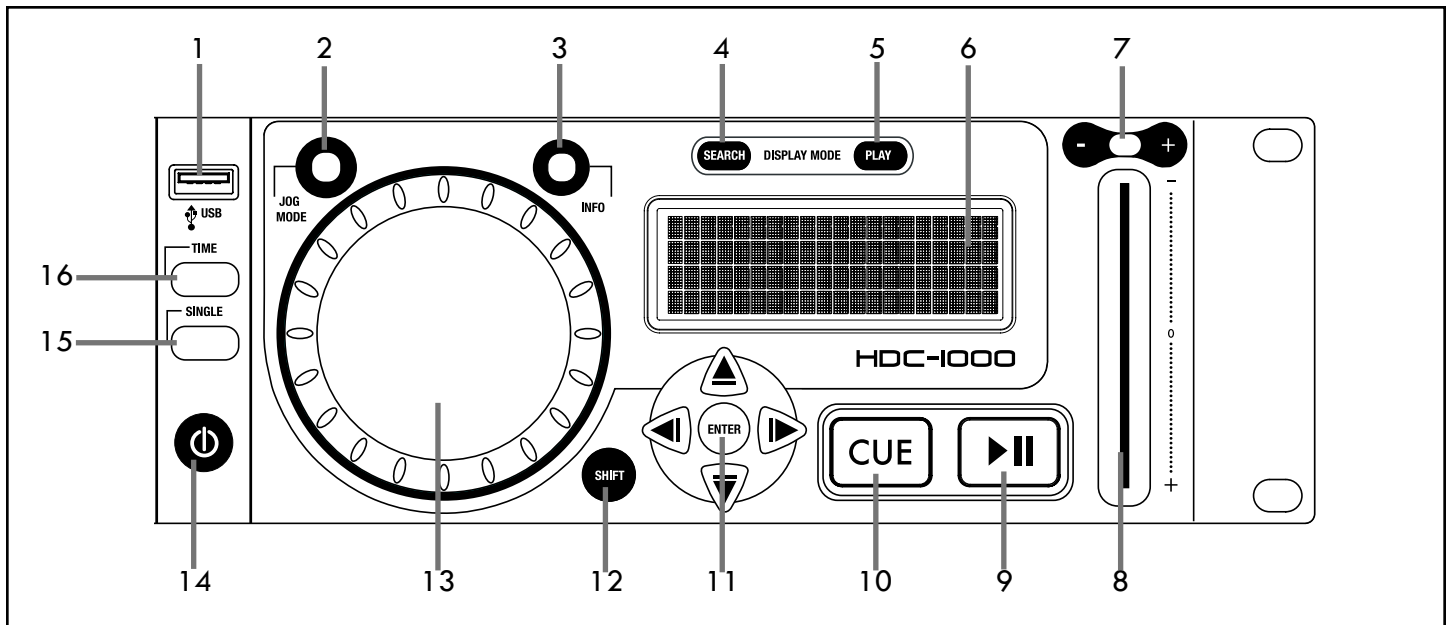
**1. USB connector (type A)**

This connector is used to attach the USB mass storage device that contains your music library. Suitable mass storage devices include, but are not limited to: external hard drives, flash memory, portable digital music players, CD/DVD-ROM drives, memory card readers, and active USB hubs.

2. JOG MODE button/indicator

Each time this button is pressed, this button controls alternately whether the JOG WHEEL will function as PITCH BEND or FF/REW. When the LED indicator is lit, it indicates that the JOG WHEEL will function as FF/REW.

3. INFO button

When this button is pressed, the LCD DISPLAY will show all of the attributes of the currently playing track. When the unit is in SEARCH MODE, pressing INFO on a highlighted digital music file will also show these attributes. The UP/DOWN arrows and JOG WHEEL can be used to advance through pages of attributes, when necessary.

4. PLAY MODE button

When this button is pressed, the LCD DISPLAY will return to the state that relates to playback. This means that the track name, time remaining (or elapsed), pitch percentage, and visual time indicators will be displayed on the screen. This button can be used at any time, with the exception of when the unit is creating a database.

5. SEARCH MODE button

When this button is pressed, the LCD DISPLAY will return to the state that relates the search function of the unit. This means that track titles, artist names, album names, genre classifications, playlists, file names, or search criteria will be displayed on the screen. This button can be used at any time, with the exception of when the unit is creating a database.

6. LCD DISPLAY panel

This blue-backlit display consists of 4 lines of 20 characters each, and is used to display visual and textual information relating to the machine state of the HDC-1000.

7. PITCH ON/OFF indicator and PITCH BEND buttons

Pressing both PITCH BEND (+) and PITCH BEND (-) simultaneously toggles whether or not the unit will respond to changes made to the pitch via the PITCH BEND buttons, PITCH CONTROL slide, and JOG WHEEL. PITCH is engaged when the LED indicator is lit. Momentary adjustments to PITCH can be made by pressing the PITCH BEND (+) or PITCH BEND (-) button. The range of the PITCH CONTROL can be changed by holding the SHIFT and pressing the PITCH BEND (+) or PITCH BEND (-) button. The pitch range will be displayed in the lower right hand corner of the LCD DISPLAY panel.

8. PITCH CONTROL slide

This slide, when pushed towards the bottom of the unit (+), increases the tempo of playback. When the slide is pushed towards the top of the unit (-), the tempo of playback is decreased.

9. PLAY/PAUSE button/indicator

When the LED indicator which illuminates this button is lit solidly, it indicates that the unit is in PLAY mode. When the LED indicator is flashing, it indicates that the unit is in PAUSE mode.

10. CUE button/indicator

When the LED indicator which illuminates this button is lit, it indicates that there is a CUE POINT memorized. See page 20 for detailed information about setting, memorizing, and recalling CUE POINTS.

Parts Diagram and Functions

Front Panel (continued)

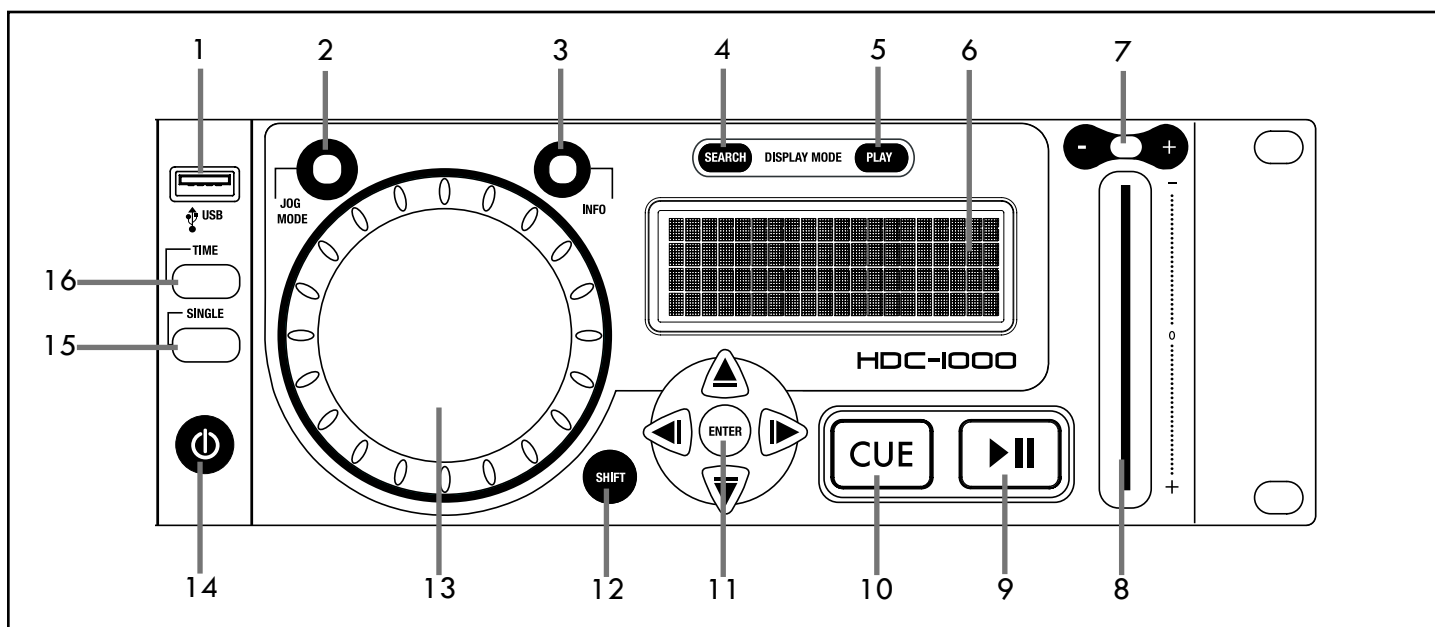
**11. NAVIGATOR keypad**

These buttons allow the user to navigate through menus and features of the HDC-1000. Depending on the mode of the unit, the buttons may serve different purposes.

12. SHIFT button

Holding down the SHIFT button extends the use of certain buttons on the unit, by providing alternate functions.

13. JOG WHEEL

The JOG WHEEL controls many aspects of the unit, and can be used for navigating through menus, searching through music and manipulation of pitch. The behavior of the JOG WHEEL is dependent on the mode of operation, as well as the status of the PITCH ON/OFF indicator and JOG MODE.

14. POWER button

The POWER button can be pressed momentarily to turn ON the unit; to turn off the unit, the POWER button must be held down for 5 seconds. Holding the SHIFT button while pressing POWER will display an additional menu, which allows for the changing and removal of USB devices, as well as setup options relating to the HDC-1000.

15. SINGLE button

When this button is pressed momentarily, the state of playback (SINGLE or CONTINUE) will be displayed on each side's respective LCD DISPLAY. To change the state of playback, hold the SHIFT button on the side of the unit you wish to change, and press the SINGLE button momentarily. The new state of playback (SINGLE or CONTINUE) will then be displayed on that side's respective LCD DISPLAY panel.

16. TIME MODE button

This button dictates whether the unit will display textual and visual time information relating to the TIME REMAINING or TIME ELAPSED. Pressing this button momentarily changes the TIME MODE of both sides of the unit, while holding SHIFT and momentarily pressing TIME will change the TIME MODE of only that respective side.

Preparing for Use

STEP ONE

Connect the AC/DC adaptor to the DC Inlet, found on the rear of the unit. Fasten the Security Clamp (found directly below the DC Inlet jack) on top of the cable, so that it is not possible for the cable to become dislodged.

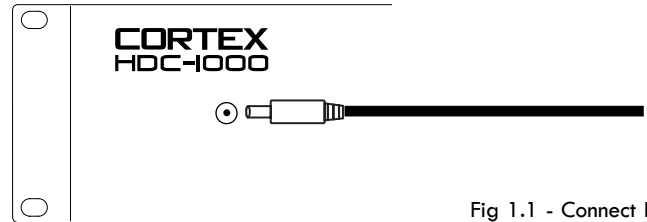

Fig 1.1 - Connect Power

STEP TWO

Connect the RCA Audio Outputs on both sides of the unit to a suitable audio mixer. When connecting the unit, make sure you note that the Side 1 outputs carry audio from the left side deck, and Side 2 outputs carry audio from the right side of the deck.

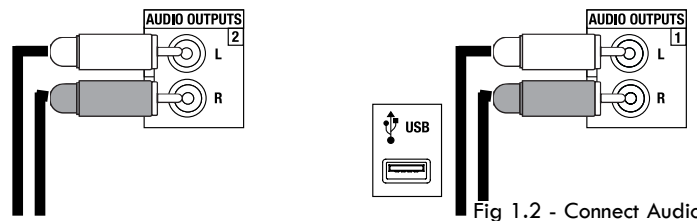

Fig 1.2 - Connect Audio

STEP THREE

Connect your primary USB device to the port found in the center of the rear panel. You may choose any driverless device that follows FAT32, NTFS, or HFS+ file systems. You may also connect a powered (active) USB hub to augment the amount of available ports. If required, you may also connect a device to the front USB port.

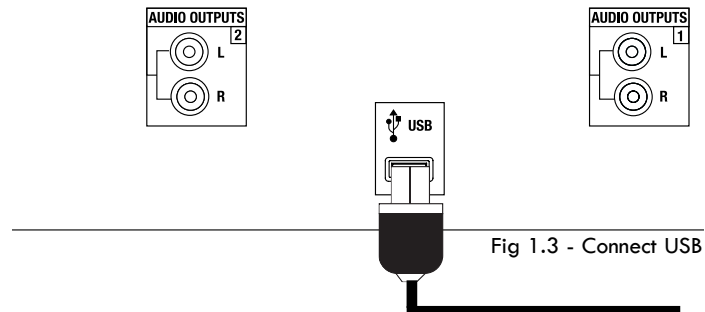

Fig 1.3 - Connect USB

STEP FOUR

Press the Power button located in the center of the front panel. The unit will take about 5 seconds to boot up as well as detect any USB devices that are currently connected.

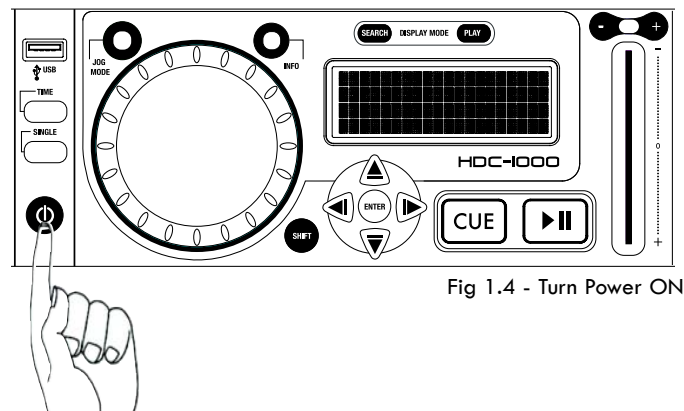

Fig 1.4 - Turn Power ON

Selecting Devices & Database Creation

STEP ONE - DEVICE SELECTION

When prompted, select the desired storage device, on each side, that you wish to access. Use the Navigator Keypad to advance through the list of devices, and press Enter to select.

If necessary, you can also connect other USB storage devices without powering down the unit.

Note that when you select a storage device on one side, the unit will be required to complete any necessary Database Creation before being able to select a device on the opposite side. During this time, the opposite screen will display "Wait for other side."

```
Select device 1/3:
>USB Mass Storage Dev.
  Maxtor RTIH24
  Apple iPod
```

Fig 2.1 - Select USB device for each side of unit

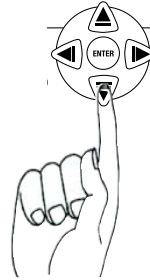

STEP TWO - INDEXING

Once you have selected a device, the unit will search for a database of the music that exists on that device. If it is the first time you are using that particular unit with the HDC-1000, the unit will prompt you to perform indexing, so that you can search for any song within seconds. If you already have used the storage device with the HDC-1000, skip to STEP TWO - VERIFICATION.

If you wish to create the database using the HDC-1000, select 'YES' from this prompt.

During the indexing procedure, the unit must create a database based off of the ID3 tags that exist on the storage device. The speed of this procedure directly relates to how many songs are stored on the connected device. If you are using a hard drive over 20 gigs, or an NTFS device, we suggest that you use the Cortex Database Creation PC application to perform the indexing, as it will save time (especially with a fast CPU). The Cortex Database Creation software is available for **FREE** from <http://www.cortex-pro.com>.

Once the indexing procedure has begun, it can be cancelled by pressing the **Info button**.

VERIFICATION

If your storage device has already been indexed, you will be presented with a prompt allowing you to verify the database. For each time that you add files to your storage device, you will either have to use the Verify function to add those files to the index, or use the Cortex Database Creation PC application.

We strongly suggest using the Database Creation application, as it can process files at many times the speed of the HDC-1000 itself.

```
Device has no
DataBase. Perform
indexing now?
<YES> NO
```

Fig 2.2 - Create Database by selecting 'YES'

```
Creating DataBase...
--< Search... >---
/Drum and Bass/
songs: 248
```

Fig 2.21 - Database Creation Screen

```
DataBase found.
Would you like to
verify it now?
YES <NO>
```

Fig 2.22 - Everytime music is added to your storage device, the database must be verified and updated in order to index the new songs.

Database Creation (continued)

STEP TWO - VERIFICATION (CONTINUED)

If you select 'YES' at the prompt to verify, you will have the option to either verify the entire database, or to verify a single directory at a time. If you keep your collection organized within separate directories, you can easily select just the directories which you know have been updated.

If you press Enter at this prompt, you will be given access to the file browser, from which you can select the directory that you wish to update. Shift+Enter will verify all directories, and might take awhile if you have a vast music library.

Once the verification procedure has begun, it can be cancelled by pressing the **Info** button.

If you choose to enter the File Browser, you then must find the directory you wish to verify. *If you are using an iPod, this will be impossible, simply due to the fact that iTunes renames all of the music on the iPod to random letters and numbers, making it impossible to differentiate between file-names.* Once you are finished verifying directories, select the very top option, labeled '<previous>'.

Once you are finished with verifying, simply choose the option labeled 'Exit from Verify.'

Congratulations! You are now ready to start searching through your music library quickly and efficiently. Using this method will help you locate any song in your collection quicker than ever before.

```

press Enter to
select dirs to verify
Shift+Enter to
verify all subdirs

```

Fig 2.3 - Verification of separate directories vs all directories

```

-<Verifying>-
>File Browser           >
Exit from Verify

```

```

-<Verifying>-
<previous>             >
.db                     >
>Calibre                >

```

Fig 2.31 - Selecting directories to verify one-at-a-time

```

-<Verifying>-
File Browser           >
>Exit from Verify

```

```

Welcome to CORTEX,
the world of
Intelligent Sound
Press any key...

```

Fig 2.4 - Welcome screen shows unit is ready for use

File Browser and Search Options

USING THE FILE BROWSER

The File Browser is designed to allow you to view the directory structure found on a connected storage device, rather than search by specific criteria. This can be helpful if you keep your music collection in order, but can also help to locate a song that may not have the appropriate ID3 tag information. When a track does not have an ID3 tag, it will not be added to the searchable database of tracks.

Once you enter the File Browser, you will be presented with the file structure exactly as it exists on the storage device. Use the Jog Wheel or the Navigator Keypad to advance through entries. To go back to the Main Menu, press the left Arrow Key.

When you have found the MP3 file that you wish to play, simply press Enter, and the track will load. You may press the **Search Mode button**, found at the top of the unit, at any time to return to the Search Options menu. Similarly, when you are in Search Mode, you may press the **Play Mode button** to return to the play screen.

SEARCH OPTIONS

The database-driven searching of the HDC-1000 provides DJs with a quick and easy way to find tracks amongst a large library, by allowing the user to search by Song, Artist, Genre, Album, or String. Simply choose one of these Search Options, and that particular criteria will be displayed in alphabetical order.

Search by Songs

When you Search by Songs, you will see presented with all of the track titles in the database that has been created by the HDC-1000 or the helper software application.

Search by Artists

When you choose Search by Artists, you can narrow down the amount of results by first selecting the artist you wish to browse, then you can easily select the track you want to play.

```
>File Browser
  All Songs
  Search by Artists
  Search by Genres
```

Fig 2.5 - Selecting File Browser from Main Menu

```
<previous> >
  .db >
>Calibre >
  Dr. S Gachet >
```

Fig 2.51 - Browsing file/directory structure using File Browser

```
<previous> >
Calibre - All the While.m
Calibre - Domeron.mp3
Calibre - Second Sun.mp
```

Fig 2.52 - Browsing files in the Calibre dir using File Browser

```
> <previous> >
  All the While
  Barracuda
  Chicken in a Basket
```

Fig 2.6 - Searching by song title

```
> <previous> >
  Calibre
  Chris Paul & Mia V
  D-Bridge
```

Fig 2.61 - Searching by artist

Search Options (continued)

SEARCH OPTIONS (CONTINUED)

Search by Genres

When Search by Genres is chosen, you will be presented with a list of all of the genres found in the database. Because not every MP3 has ID3 genre tagging, some tracks may not be displayed in this search. Once you select a genre from the list, you will be able to browse all songs within that genre.

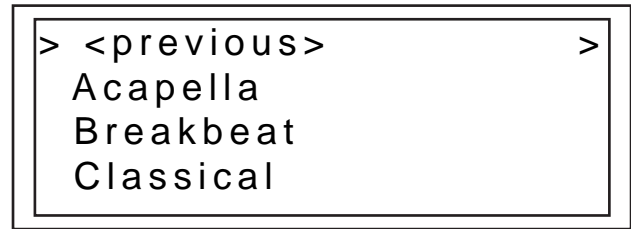

Fig 2.63 - Searching by genre

Search by Album

Using the Search by Album option will allow you to search by the name of the album that a track is from. Keep in mind that this option also may not allow you to access all tracks, because sometimes singles are sold separately and are not taken from any specific album. Once you select an album, all of the tracks found under that album will be displayed.



Fig 2.64 - Searching by album

Search by String

One of the most convenient features of the HDC-1000 is string search, which allows you to find a specified word or string of words within the database. This is exceptionally helpful when you (or your client) has a request, but does not know the exact title or artist.

Once you have selected 'Search by String,' you will be presented with a prompt where you may input a word or series of words that will be used when querying the database.

Using the Jog Wheel or Up/Down arrows (on the Navigator Keypad), enter the first letter of the Search String. Use the Right arrow or the Enter Key to advance to the next space, and enter the next letter. You may press the Left arrow to go back to the previous letter, or press Shift+Left to backspace (deletes the previous letter).

Finally, when the Search String is entered, you will need to press the Enter key twice, and the unit will execute the search.

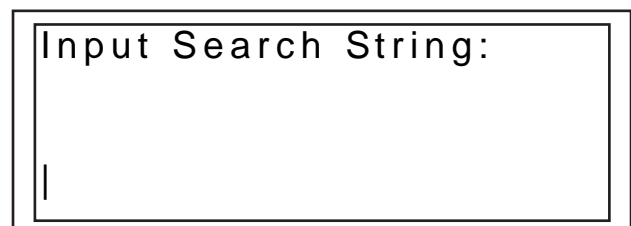

Fig 2.65 - String Search input prompt

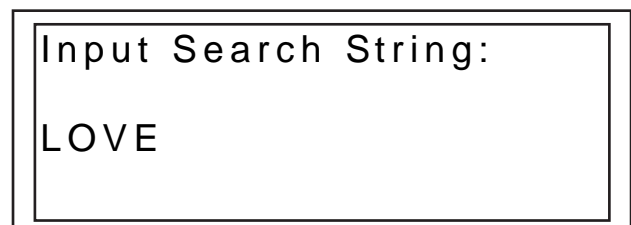

Fig 2.66 - Using Jog Wheel to input a string

Search Options (continued)

SEARCH OPTIONS (CONTINUED)

Once you press Enter twice, the unit will begin processing your search. Depending on the size of your library, this may take awhile.

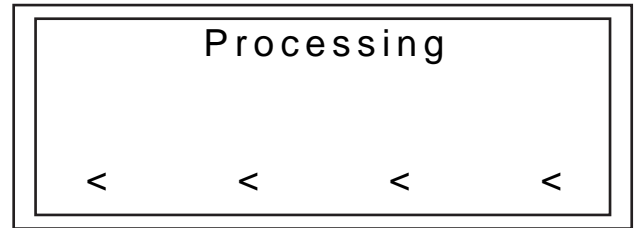

Fig 2.67 - Processing the Search

After the unit is finished executing the search, it will display the results that were found for each category: Titles, Artists, Genres, and Albums - each of which can be accessed by using the Navigation Pad Arrow Keys or the Jog Wheel. Note that the amount of results found under each category will be displayed in parenthesis. In this example, there are 10 titles of songs with the word "LOVE" in them, and 1 artist.

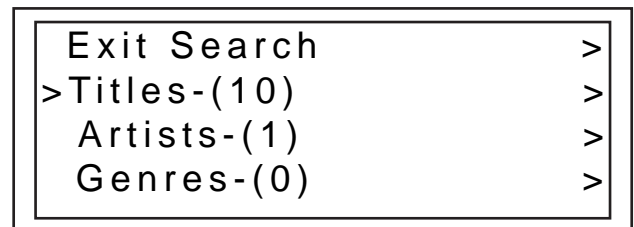

Fig 2.68 - Displaying result categories

Once you have chosen a category - Titles, Artists, Genres, or Albums, you will browse through the selections as if you were in any of the other search modes. Once again, you may select a track using the Jog Wheel or Navigation Pad, and press Enter to load it.

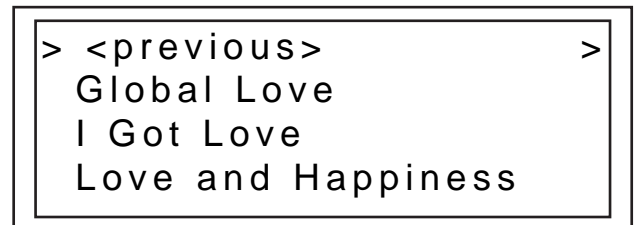

Fig 2.69 - Selecting a matching title from the executed search

Info Button & Track Attributes

You will find that the Info Button, located to the top right of each jog wheel, will become an indispensable part of using the HDC-1000. Despite the HDC-1000 being able to display an adequate amount of information on the LCD, not every attribute of each track can be displayed all at once. Additionally, there will be times when you may run into two tracks with the same title, and the Info Button will help to reveal which track you truly want to select.

While in Play Mode or Search Mode, pressing the Info button will display all attributes relating to the currently playing or currently selected track (depending on whether you are in Play or Search Mode).

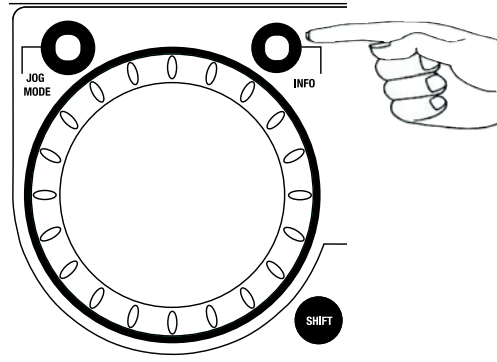

Fig 2.7 - The Info Button is used to display all track attributes

The Info function displays:

Artist - Artist as per what is listed in the ID3 tag

Title - Title as per what is listed in the ID3 tag

Album - Album as per what is listed in the ID3 tag

Type of File - Whether the file is MP3 or WAV

Genre - Genre as per what is listed in the ID3 tag

Path & Filename - Exactly how it exists in the directory structure of the storage device

```
artist : Stunna & Contour
title  : Neverlove
album:
type   : mp3
```

Fig 2.71 - Information Screen 1 of 3

Note that most of the attributes are taken directly from the ID3 tag found in the MP3 file. If the ID3 tag is missing any of these attributes, they will not be displayed in the Info screens.

Once you have pressed the Info button, you will be presented with all of the attributes relating to the currently playing or selected track. You may use the Navigation Pad Arrow Keys or the Jog Wheel to scroll up and down to view all of the information.

```
genre: Drum and Bass
time  : 05.56
path  : /songs/dnb/Stunna
       /Stunna and Contour - Ne
```

Fig 2.72 - Information Screen 2 of 3

To exit the Info screens, you may press the Info Button again, or you may press either the Search or Play Mode buttons to jump immediately to those modes, when applicable.

```
verlove_PHUNK007.mp3
size  : 7452 Kb
```

Fig 2.73 - Information Screen 3 of 3

Play Mode and Single Auto Cue

Section Five: Play Mode

The Play Mode is the heart of the Cortex HDC-1000. Just like conventional CD players, the HDC-1000 allows you to select multiple pitch ranges, memorize cue points, and frame accurate searching. The HDC-1000 excels over traditional CD players, as it is much faster at loading and starting playback, it has a more informative LCD display, and it can memorize cue points for future performances.

Entering Play Mode

By default, when you press Enter to select a track from Search Mode, the unit will immediately load the track and enter Play Mode.

If music is already playing and you wish to return to the Play Mode screen, simply press the **Play Mode button**.

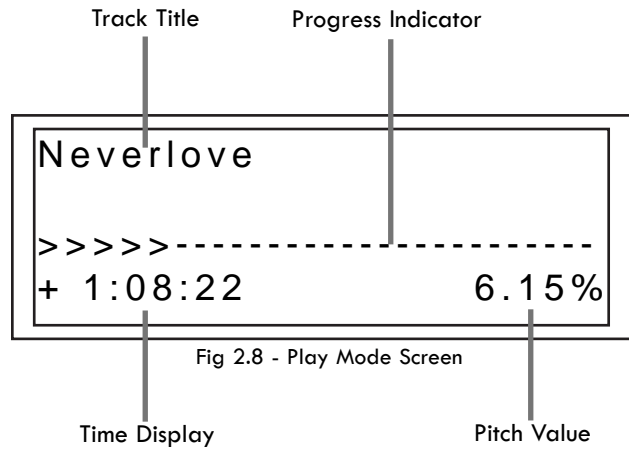

Fig 2.8 - Play Mode Screen

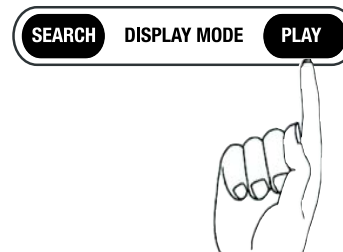

Fig 2.81 - Entering Play Mode

Single Mode (Single Auto Cue)

Single Mode, when a track is loaded, will automatically cue to the first frame of audio, and then wait for you to press Play. At the end of that track, the unit will pause. To engage this mode, press **Shift+Single** on each side you wish to engage this mode on.

When Single Mode is off when loading a track, the unit will begin playing immediately. At the end of that track, the unit will continue to play the next file displayed in the Search Results. When Single Mode is off, this gives you the ability to play all of the Search Results in the order that they were displayed. Pressing **Shift+Single** on each side will also allow you to turn Single Mode off.

Pressing the **Single button** by itself will display, on both screens, the status of each side - whether or not Single Mode is on or off.

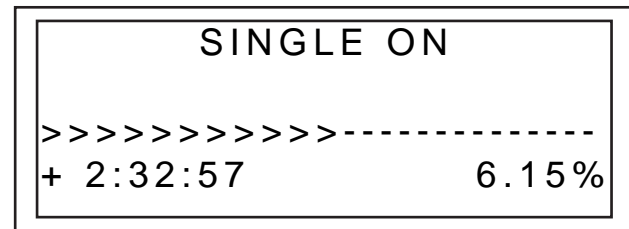

Fig 2.82 - LCD Display shows status of Single Mode

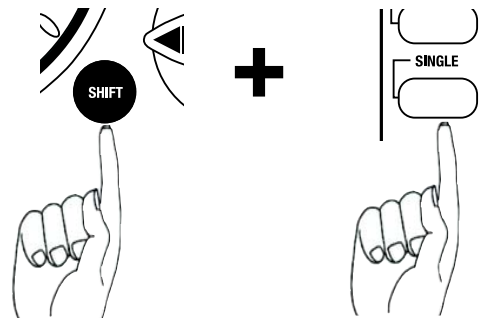

Fig 2.83 - Using Shift+Single to toggle Single or Continuous modes

Time Display and Pitch Control

Time Display Modes

Changing the Time Display Mode is as simple as pressing the **Time button** to toggle between elapsed and remaining time. Elapsed Time shows how much time has past since the beginning of the track, and Remaining Time shows how much time is left before the track is over.

You may press **Shift+Time** to change the Time Display Mode for each side individually.

When the Time Display Mode is changed, you will also notice that the Progress Indicator will also change to reflect either Elapsed Time or Remaining Time.

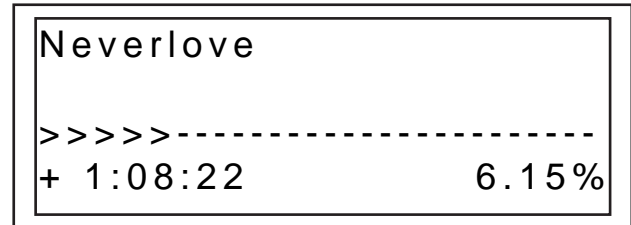

Fig 2.9 - LCD Display and progress indicator in time elapsed

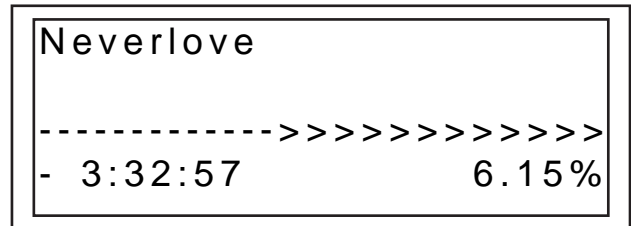

Fig 2.91 - LCD Display and progress indicator in time remaining

Pitch Control, Pitch Bend, and Pitch Ranges

The Pitch Control allows you to speed up (or slow down) the playback of a track by a desired percentage. The HDC-1000 offers Pitch Ranges of 4, 8, 16, and 24%, in order to provide a wide level of flexibility when manipulating digital music files. In 4 and 8% mode, 0.05% Pitch Resolution can be achieved, allowing for a more precise level of adjustment.

To toggle Pitch On or Off (the unit will not respond to pitch changes when Pitch is Off), press both the **Pitch Bend (+)** and **Pitch Bend (-)** buttons simultaneously. The LED indicator will illuminate when Pitch has been turned On.

To change Pitch Ranges, press **Shift+Pitch Bend (+)** OR **Pitch Bend (-)** buttons simultaneously. The Pitch Display on the LCD screen of that respective side will momentarily display the new Pitch Range.

For a momentary change in Pitch, the **Pitch Bend (+)** and **Pitch Bend (-)** buttons will temporarily increase or decrease pitch relative to the amount of time either button is held down.

When the Jog Mode is not engaged (LED remains unlit), you may also use the **Jog Wheel** to perform a Pitch Bend.

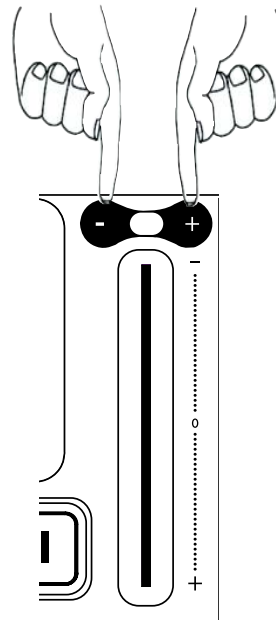

Fig 2.91 - Pitch On/Off by pressing both buttons simultaneously

Jog Mode and Playback Navigation

Jog Mode

When the **Jog Mode LED** is unlit, the **Jog Wheel** (when in Play Mode) will perform a Pitch Bend.

When the **Jog Mode button** is pressed, the LED indicator will illuminate, and the **Jog Wheel** will then allow you to search (FF/REW) through each track. The faster the **Jog Wheel** is moved, the faster the unit will search through the playing track. In order to use the **Jog Mode**, the unit must be in the process of playing, *not* paused.

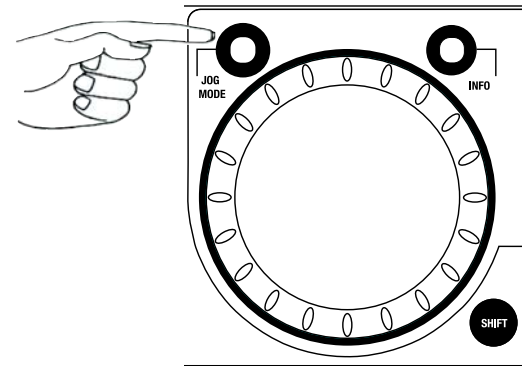

Fig 3 - Engaging Jog Mode for FF/REW using the Jog Mode button

Playback Navigation Functions

Using the **Navigation keypad left & right buttons**, you can search through a track similar to using the Jog Mode function.

Using the **Navigation keypad up & down buttons** will allow you to skip to the previous or next track that was found in the Search Results. For instance, if you searched by Artist, and your Search Results displayed 10 tracks by that Artist, using the **Navigation keypad up & down buttons** will allow you to skip between those tracks.

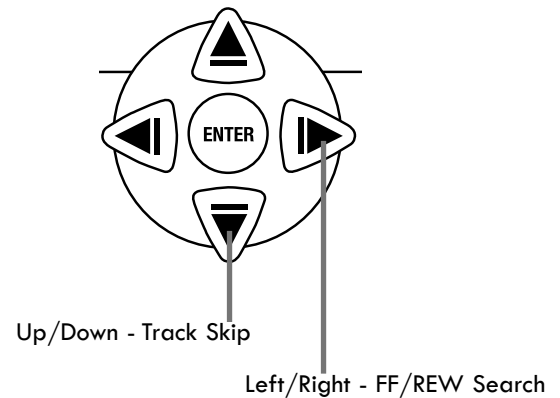

Fig 3.1 - Navigation keypad functions in Play mode

iPodPlaylist Support

Although there is no facility to create playlists on the HDC-1000 unit, you can load iPod playlists that are created using iTunes®.

Once a playlist has been constructed using iTunes®, it can be loaded from the main Search Options screen.



Fig 3.2 - iPod Playlist option from the Search Menu

Creating a Simple Playlist

When using the File Browser with Single Mode OFF, you can play all of the files in a specified directory simply by choosing the first file and letting the unit continue playing. If you change the filenames (via your PC) to be preceded by a number, the HDC-1000 will play them in numeric order.

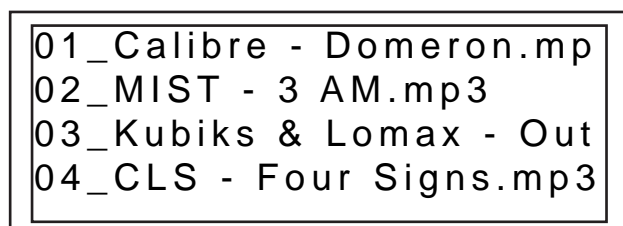

Fig 3.3 - Simple Playlist by using numbered files with File Browser

Cue Points & Memorization

Setting and Memorizing Cue Points

With the HDC-1000, creating and memorizing cue points is quick and easy.

By default, when there is no Cue Point set (or memorized), pressing the **Cue button** returns the unit to the beginning of the track (0:00.00) and pauses.

To set a Cue Point during playback at a time of your choice, simply press **Pause**, and then use the **Navigation keypad left & right buttons** or **Jog Wheel** to make any adjustments by frame. When **Play** is pressed to resume playback, the Cue Point will be stored.

To memorize the Cue Point and save it to the USB storage device (to be recalled each time the track is loaded), find the exact frame that you wish to set as a Cue Point, and press **Shift+Cue**. This will permanently set & save the Cue Point to the storage device. This process can also be done on the fly, without the unit being paused. The screen will indicate when a Cue Point has been stored.

To advance back to the set Cue Point, simply press the **Cue button** during playback. Do not press **Pause** first, as this will instead set a new point. Once advanced to the Cue Point, the unit will remain in Pause mode.

To memorize a new Cue Point, you do not have to erase the previously set one. You can simply press **Shift+Cue** again, and it will replace the old Cue Point.

Please note that in order for a Cue Point to be saved to the connected USB storage device, it must be a FAT32 file system.

To erase the saved Cue Point completely, hold **Shift** and press **Cue** for two seconds, until the screen indicates that the Cue Point has been deleted.

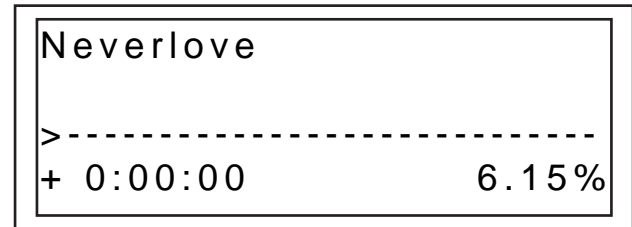

Fig 3.4 - Pressing CUE to return to 0:00:00.

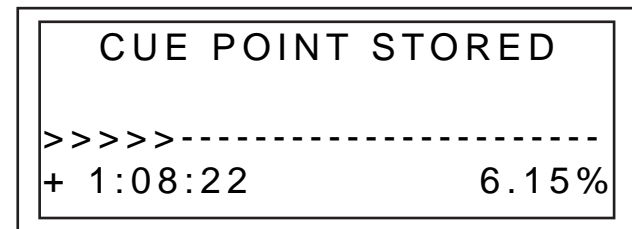
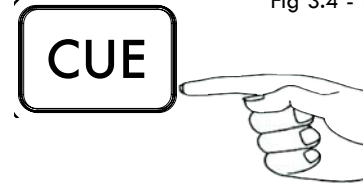

Fig 3.41 - Cue Point Memorization using Shift+Cue

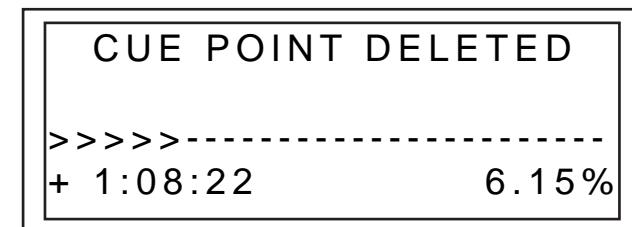
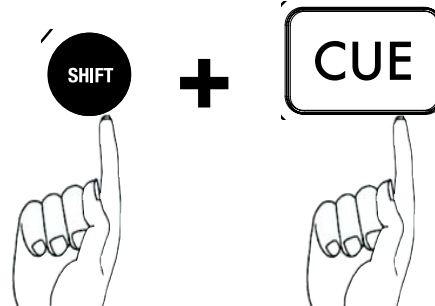
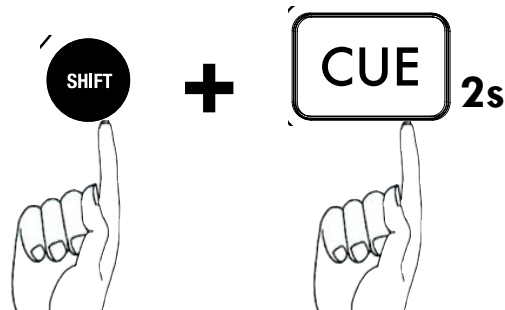

Fig 3.41 - Cue Point Deletion using Shift+Cue



Device Menu

Changing, Adding, and Ejecting USB Storage Devices

To access the **Device Menu** from any screen, press **Shift+Power**. From this menu, you can choose to Change or Eject Devices.

Since USB is hot-pluggable, you can connect (but not disconnect) a USB device at any time, regardless of whether the unit is powered On or not and regardless of what mode the unit is in.

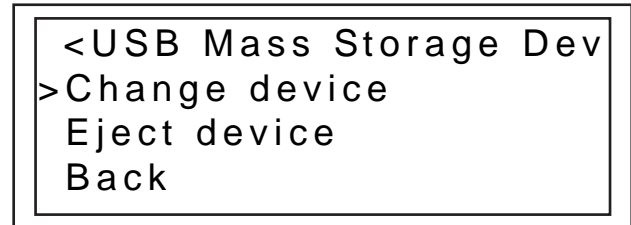
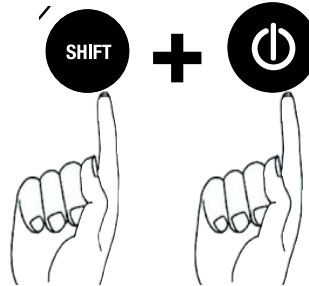

Fig 3.5 - Pressing Shift+Power to access the Device Menu



- To Change devices:

1. Select **Change device** from the **Device Menu**.
2. Select the new device you wish to switch to using the **Navigation keypad** or **Jog Wheel**.
3. Perform any necessary cataloging or verification (as found in **Section Two: Selecting Devices & Database Creation**)

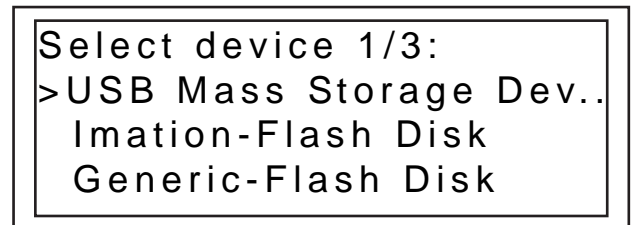

Fig 3.51 - Selecting another device using the Keypad/Jog Wheel

- To Eject devices:

1. Select **Eject device** from the **Device Menu**.
2. Select the new device you wish to Eject using the **Navigation keypad** or **Jog Wheel**. Press Enter to eject the device.
3. If the device you have ejected is being used by both sides of the HDC-1000, the unit will warn you by displaying "The device is also attached to other side!" This simply means that if you intend to remove the device from the HDC-1000, you must eject both sides before unplugging it.
4. When the display reads "The device can be safely removed," you may disconnect the USB device.
5. If you are using a USB CD-ROM or DVD-ROM drive, you must use the Eject procedure in order to open the CD/DVD tray.

If the Eject procedure is not followed, there is risk of corrupting any files that are open when the device is disconnected.

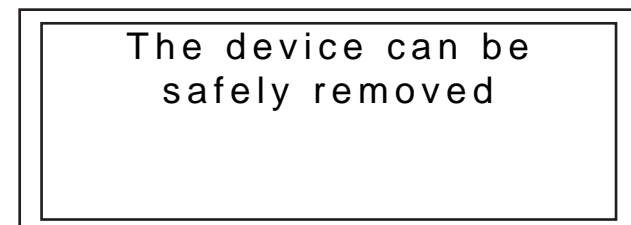

Fig 3.6 - Only remove the USB device after the eject procedure

Shuffle Mode & Soft Power

Shuffle Mode

A useful feature for unattended playback is Shuffle Mode. This feature randomly selects tracks based on what is narrowed down using the Search Criteria. For instance, if you select All Songs as your Search Criteria, then the unit will randomly select any song in that list. If you select Search by Artist, the unit will randomly select music from that Artist only. The same applies to Genre, Album, String, or even the File Browser.

Shuffle Mode is toggled on and off by pressing **Shift+Info**, for each side that you wish to change. Each respective LCD display will indicate when Shuffle has been engaged or disengaged.

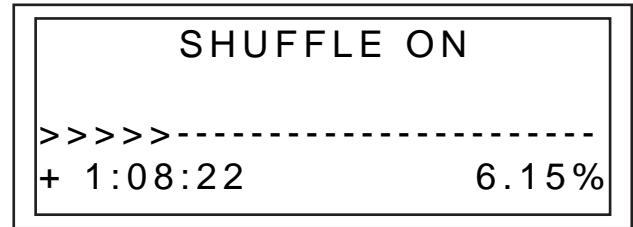

Fig 3.7 - LCD Display shows Shuffle Status

Powering the Unit Off

Similar to modern computers, the HDC-1000 has a soft-power-off feature, as the unit has to close all connections with USB devices and go through a shut down procedure before the power is removed. This also protects against accidentally turning the power off.

In order to power down the HDC-1000, simply hold the **Power Button** down for 3 seconds.

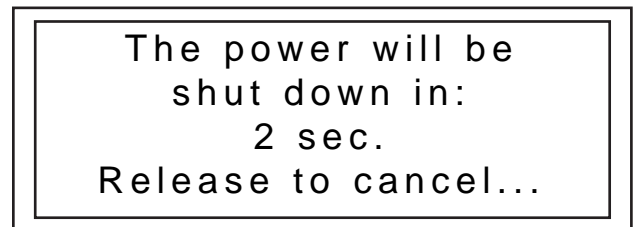

Fig 3.8 - HDC-1000 Shutdown Procedure

Setup Preferences

Setup Menu

Because everybody has their own preferences, we have included a very simple Setup Menu, so that each time the unit is turned on, it defaults to the choices you have selected. *Each side of the HDC-1000 must be configured separately.*

The Setup Menu can be accessed as the final option on the Main Menu. Each option is changed by pressing the **Enter key** repeatedly. To exit the Setup Menu, simply press the **left arrow key** on the **Navigator keypad**.

Pitch Bend - slow, norm, and fast

- **slow** : bends at a rate of approx. **1%** per second
- **norm** : bends at a rate of approx. **2%** per second
- **fast** : bends at a rate of approx. **4%** per second

Enable Pitch - on/off

This determines whether or not the pitch function will be enabled on start-up or not. Some entertainers who never use the pitch function will prefer to turn this 'off'.

Pitch Range - 4, 8, 16, 24%

This determines the default Pitch Range when the unit is first powered on. 4 or 8% Pitch Range will allow much finer adjustment, using 0.05% Pitch Resolution.

Indexing - on/off

When this is set to 'off,' the unit will never prompt to create a database. This is useful for DJs that already keep a meticulous organization system of directories, or for permanent installations.

Time - elapsed/remain

This option toggles the default time display to show either time elapsed or time remaining during the playback of each track.

Shuffle - on/off

When this option is enabled, the unit will play at random, based on the search criteria. If you select 'All Songs', it will shuffle all songs. If you select 'The Jerolds' as an Artist, it will shuffle all songs by The Jerolds.

Single - on/off

This toggles whether the unit will default to Single Auto-Cue mode or Continuous mode when powered on.



```

Search by Albums
Search by String
iPod Playlists
> Setup Menu
  
```

Fig 3.9 - Setup Menu is the last option from the Search Options

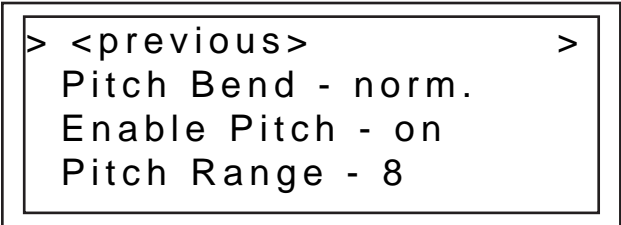

```

> <previous> >
Pitch Bend - norm.
Enable Pitch - on
Pitch Range - 8
  
```

Fig 3.91 - Setup Menu page 1 of 2

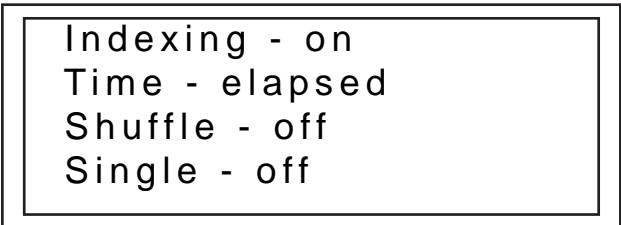

```

Indexing - on
Time - elapsed
Shuffle - off
Single - off
  
```

Fig 3.92 - Setup Menu page 2 of 2

Firmware Updates

Firmware Updates

One of the most powerful features of the HDC-1000 is the capability to upgrade the internal software. This lends itself to the addition of new features and support, the optimization of current processes, and the capability to fix bugs as they arise.

Firmware updates will be issued periodically at <http://www.cortex-pro.com>.

We suggest that you stay as current as possible with all updates in order to insure the highest level of functionality and compatibility that Cortex has to offer.

To check the version of firmware installed:

1. Power on the HDC-1000 with **NO DEVICES CONNECTED**.
2. At the prompt that says 'Insert Devices,' press the INFO button.
3. The screen will display the version number of the currently installed HDC-1000 firmware.

To update the firmware, follow these steps:

1. Using Internet Explorer ONLY, download the latest firmware upgrade from <http://www.cortex-pro.com>. Other web browsers may rename the file extension, which will result in the unit not recognizing the update file.
2. Place the file in the root directory of your external USB storage device.
3. Connect the USB storage device to the HDC-1000, and select it from the Device Menu (during startup). Make sure your HDC-1000 is connected to a stable power source, where there is no potential of the unit losing power during update.
4. When the HDC-1000 detects the firmware in the root directory of the USB storage device, it will ask you if you want to apply the update. You must answer YES. If the version of firmware on the storage device is the same or older than what you have, it will be ignored.
5. When updating, the unit will go through 6 stages. This will take only a few minutes. If the power is interrupted or the USB device is removed during this process, it can damage the operating system of the unit.

6. When the update is completed, the unit will shut itself down. You must press power to restart the unit. Once the unit has booted up again, the new software will take effect. You may then erase the firmware update from your USB device at your convenience (it will not be detected again).

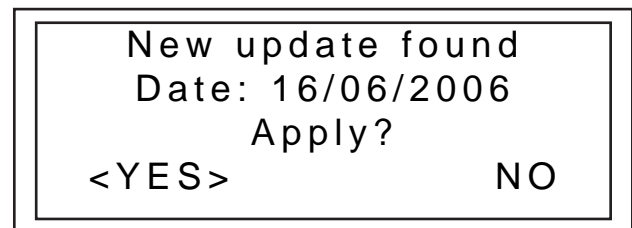

Fig 4.1 - Automatic detection of new firmware, option to update

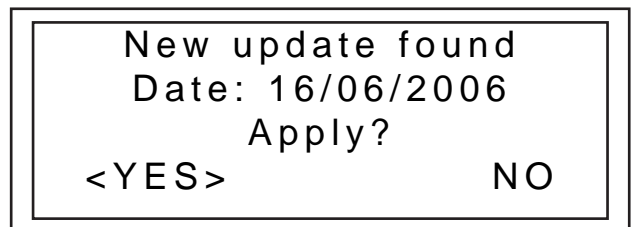

Fig 4.1 - Automatic detection of new firmware, option to update

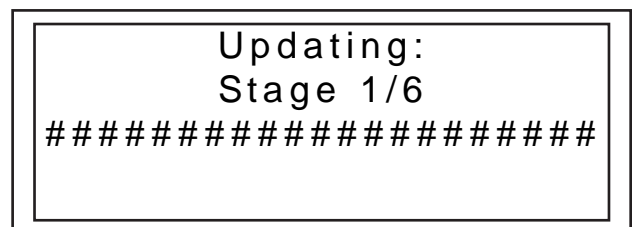

Fig 4.2 - Updating the firmware in 6 stages

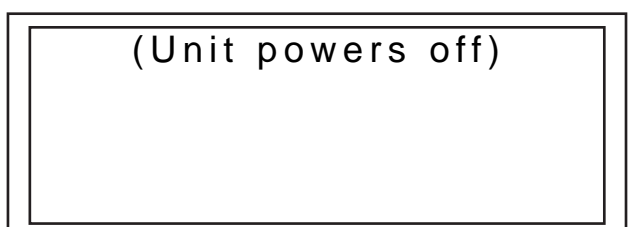

Fig 4.3 - Power shuts off completely when the update is complete

Error Messages

If you experience an error message while navigating the unit, here are a few explanations of those errors and how they can be corrected. For a more complete troubleshooting guide, consult our website at <http://www.cortex-pro.com>.

“**Can't access device**” will be displayed because of one of the following problems with the storage device:

- Device is write protected

In the case of a USB flash drive, some units have a switch to enable write-access.

- Device has already been ejected using the eject procedure. Remove the USB device and plug it back in.

- Device is using an unsupported file system

The file systems supported are FAT32, NTFS, HFS+, CDFS, and UDFS.

- Device is not able to run without a proprietary hardware driver

Some devices require proprietary hardware device drivers. Although with the introduction of USB, this is less common, it still sometimes presents an issue. These devices are not compatible with the HDC-1000.

- Device has been removed while before using the eject procedure

If the device is removed from the USB port without using the proper ejection procedure, it is possible that the unit will not detect the absence of a USB storage device, and will try to access the port anyway.

- If the device is powered by an external power supply, make sure that the unit is receiving power.

- If the device has just been plugged in, and it was immediately selected, the drive might not be ready to be accessed. Wait 10 seconds and try again.

“**Error creating DB**” may be displayed if there is not a sufficient amount of space left on your storage device to create the necessary database files required to search through your music library.

- If you are out of space, try to delete some files and try the database process again.

- Check the USB cable that is being used to connect the storage device to the HDC-1000.

- If the device is powered by an external power supply, make sure that the unit is receiving power.

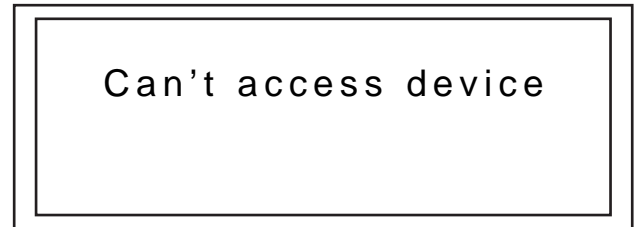

Fig 4.4 - Error message, Can't access device

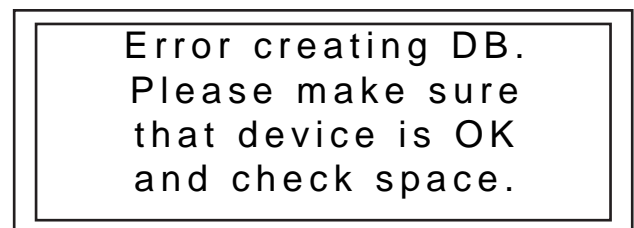

Fig 4.5 - Error message, drive full or not responding

Specifications

1. General

Type of unit.....	Streaming Digital Audio Controller
Format compatability.....	MP3, WAV, CD-Audio
MP3 format.....	8 kbps ~ 320 kbps, CBR/VBR, 44.1 kHz
WAV format.....	44.1 kHz, 16 bit stereo
Instant Start.....	<0.1 second
Pitch ranges.....	4, 8, 16, 24%
Pitch increment.....	0.05% at 4 and 8%
.....	0.1% at 16 and 24%
Power.....	AC 100~240V, 50/60 Hz
Power consumption.....	12 watts
Operating environment temp.....	+5° C to +35° C (+41° F - +95° F)
Operating environment humidity.....	5-85%
Weight.....	3.75 lbs
.....	1.7 kgs
Dimensions.....	19 x 2 17/32 x 3 15/32 inches
.....	482 x 64 x 88mm

2. Audio output section

Audio output.....	4 Channel (2x2)
Output level.....	1.0 V RMS (1 kHz, 0dB)
Output connectors.....	Unbalanced RCA Type
Frequency response.....	20 Hz - 22 kHz
S/N ratio.....	90dB
Total harmonic distortion.....	<0.05%

3. USB interface section

Connector type.....	USB Type A
USB protocol support.....	1.0, 1.1 (Full Speed) and 2.0 (Hi-Speed)
Number of ports.....	2
Maximum number of connected devices (via USB hub, sold separately).....	8
File system support.....	FAT32, NTFS, HFS+, CDFS, UDFS

4. Included Accessories

RCA audio cables.....	2
Power supply.....	1
Tabletop mounting stands.....	2
Mounting hardware for tabletop stands.....	1
Operating instructions.....	1
Warranty Card.....	1
USB port protector cap.....	1

5. Replaceable Parts (order from GCI by part number if needed)

Power supply.....	USA 110v 059-347
.....	VDE (Europe) 059-348-R
.....	UK 059-349-R
.....	JIS (Japan) 059-350
Power cable strain relief clamp.....	049-231-R
Tabletop mounting stands.....	022-893-R (left) and 022-894-R (right)
Mounting stand rubber pads (uses 2).....	049-230-R
Mounting stand screw BTS-3.4x10 AB (uses 6).....	111-059A-R
Mounting stand plain washer PW 4.0MM (uses 6).....	142-044-R
Mounting stand plain washer PW4.2x12x0.5t (uses 6).....	142-045-R
USB port protector cap.....	003-807-R
Pitch control knob.....	002-743-R

Should your Cortex product require warranty or non-warranty service in the USA, or if you wish to purchase replacement parts, operating instructions, or accessories, please contact GCI Technologies at the phone number listed below:

732-738-9003

Do not, under any circumstance, ship your product to GCI without first calling the Technical Support Department at the number listed above. Failure to establish an RMA (Return Merchandise Authorization) number prior to shipping your product will delay your repair indefinitely. GCI reserves the right to refuse all packages that arrive without an RMA number.

For warranty information, please refer to the warranty page included in this manual.

Once an RMA number is established, your unit should be sent to the address specified by your customer service representative, with the RMA clearly written on the outer carton:

For support or repair outside of the USA, please visit the Cortex website at <http://www.cortex-pro.com>.

Published by GCI Technologies Corporation
Copyright © 2006 GCI Technologies Corp.
All rights reserved.

Features & specifications subject to change without notice.



GCI Technologies USA:	+1 (732)738-9003
GCI Latin America and Caribbean:	+1 (305)592-4746
GCI United Kingdom LTD:	+44 (0)87 087-00880
GCI France	+ 33 1 69 79 97 72
GCI SA (Spain):	+34 93 436 37 00
GCI GmbH (Germany):	+49 8131 39171-0



Cortex products are designed and manufactured to the highest standards in professional audio. With proper care and maintenance, your product will provide years of reliable service. Please register your product online at <http://www.cortex-pro.com>

Limited Warranty:

In the USA, Cortex guarantees its products against defects in workmanship for the period of One (1) year* from the original date of purchase.

This limited warranty does **not** cover damage or failure caused by abuse, misuse, abnormal use, faulty installation, improper maintenance or any repairs other than those provided by an authorized servicer.

There are no obligations of liability on the part of GCI, Cortex, or any of its retailers for consequential damages arising out of or in connection with the use or performance of the product or other indirect damages with respect to loss of property, revenues, profit, or costs of removal, installation, or reinstallation. All implied warranties for GCI, including implied warranties for fitness, are limited in duration to **One (1) year** from the original date of purchase, **unless otherwise mandated by local statutes.**

Returning Your Product for Service:

In the U.S.A., please call our helpful Customer Service Representatives at (732)738-9003, and they will be happy to give you a **Return Merchandise Authorization (RMA)** number and the address of an authorized service center closest to you.

After receiving an **RMA**, include a **copy** of the **original sales receipt**, with defective product and a description of the defect. Send by insured freight to GCI Technologies Corporation, and use the address provided by your customer service representative. **Your RMA must be written on the outside of the package, or processing will be delayed indefinitely! GCI reserves the right to refuse all packages that arrive without an RMA number.**

Service covered under warranty will be paid for by GCI and returned to you. For non-warranted products, GCI will repair your unit after payment is received. Repair charges do not include return freight. Freight charges will be added to the repair charges.

Your warranty is valid only in the country where the unit has been purchased. Repairs performed outside of the country of purchase will be treated as out-of-warranty.

For warranty service, **you pay for shipping to GCI; we pay for return shipping within the Continental United States.** Alaska, Hawaii, Puerto Rico, Canada, Bahamas, and the Virgin Islands **will be charged for freight.**

Please allow **2-4 weeks** for return of your product. Under normal circumstances your product will spend no more than **10** working days at GCI. We are not responsible for shipping times.

For repairs and warranty information outside of the USA, please call the GCI affiliate closest to where you reside, listed on the specifications page of this manual (page 40), or visit the Cortex website at <http://www.cortex-pro.com>.

* Unless otherwise mandated by local statutes.

For Your Records

Model Number of Product:
(HDC-1000, HDC-3000, HD-TT5000)

Serial Number of Product:
found on rear panel of unit

Original Purchase Date:

Name of Retailer:

Please register your warranty online at <http://www.cortex-pro.com>

cortex-pro.com

